

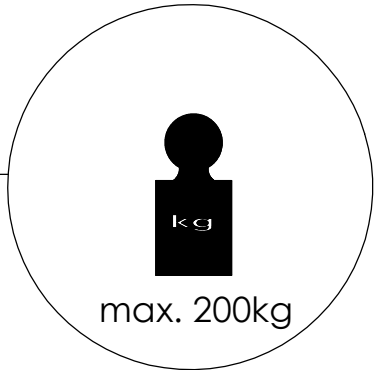

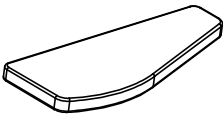









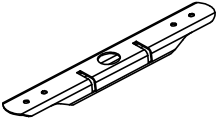

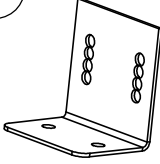
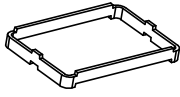
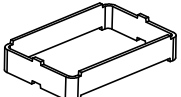
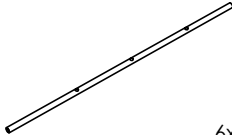
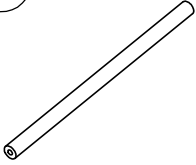
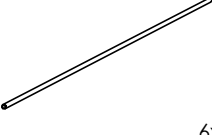
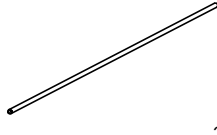
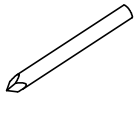

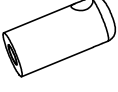
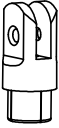
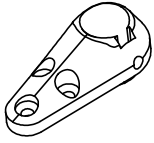
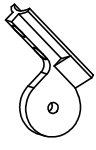



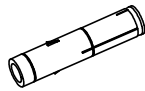
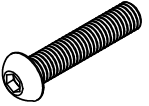

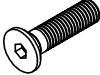



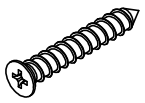



H	
8	1520 - 1830 mm
9	1710 - 2060 mm
10	1900 - 2290 mm
11	2090 - 2520 mm
12	2280 - 2750 mm
13	2470 - 2980 mm

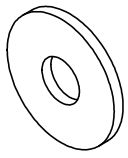

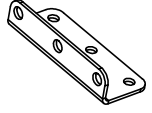
<p>Q01</p>  <p>13x</p>	<p>Q02</p>  <p>1x</p>	<p>Q03</p>  <p>11x</p>		<p>Q04</p>  <p>1x</p>
<p>Q05</p>  <p>13x</p>	<p>Q06</p>  <p>1x</p>	<p>Q07</p>  <p>2x</p>	<p>Q08</p>  <p>1x</p>	<p>Q09</p>  <p>1x</p>
<p>Q10</p>  <p>6x</p> <p>Ø 22x1x1100mm</p>	<p>Q11</p>  <p>4x</p> <p>Ø 40 x 750 mm</p>	<p>Q12</p>  <p>6x</p> <p>Ø 6x1x900 mm</p>	<p>Q13</p>  <p>3x</p> <p>Ø 6x1x1200 mm</p>	<p>Q14</p>  <p>6x</p> <p>Ø 4 x 40 mm</p>
<p>Q15</p>  <p>6x</p> <p>Ø 6 x 12 mm</p>	<p>Q16</p>  <p>18x</p> <p>Ø 12,5 x 28 mm</p>	<p>Q17</p>  <p>6x</p>	<p>Q18</p>  <p>12x</p>	<p>Q19</p>  <p>6x</p>
<p>Q20</p>  <p>6x</p> <p>Ø 22 mm</p>	<p>Q21</p>  <p>2x</p> <p>Ø 40 mm</p>	<p>Q22</p>  <p>3x</p> <p>Ø 15 x 50 mm</p>	<p>Q23</p>  <p>8x</p> <p>Ø 12 mm</p>	<p>Q24</p>  <p>8x</p> <p>M8 x 60 mm</p>
<p>Q25</p>  <p>56x</p> <p>M10 x 20 mm</p>	<p>Q26</p>  <p>6x</p> <p>M5 x 20 mm</p>	<p>Q27</p>  <p>18x</p> <p>M6 x 14 mm</p>	<p>Q28</p>  <p>12x</p> <p>M6 x 6 mm</p>	<p>Q29</p>  <p>52x</p> <p>Ø 6 x 30 mm</p>

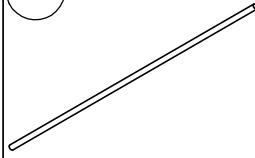
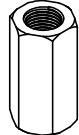
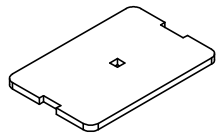
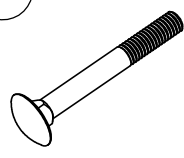
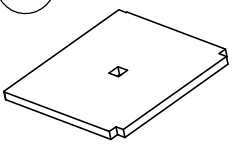
<p>Q30</p>  <p>36x</p> <p>Ø 5 x 40 mm</p>	<p>Q31</p>  <p>6x</p> <p>Ø 4 x 25 mm</p>	<p>Q32</p>  <p>20x</p> <p>Ø 3.5 x 25 mm</p>	<p>Q33</p>  <p>56x</p> <p>M10</p>	<p>Q34</p>  <p>6x</p> <p>M5 DIN 934</p>
<p>Q35</p>  <p>12x</p> <p>M6 DIN 562</p>	<p>Q36</p>  <p>104x</p> <p>M10 DIN9021</p>	<p>Q37</p>  <p>8x</p> <p>M8 DIN 125</p>	<p>Q38</p>  <p>8x</p> <p>M10 DIN 125</p>	<p>Q39</p>  <p>2x</p>
<p>Q53</p>  <p>12x</p> <p>M6 x16mm</p>	<p>Q54</p>  <p>12x</p> <p>M6 x350mm</p>	<p>Q55</p>  <p>25x</p> <p>M6 DIN6334</p>	<p>Q56</p>  <p>12x</p>	<p>Q57</p>  <p>1x</p> <p>M6 x 50mm</p>
<p>Q58</p>  <p>1x</p>	<p>Q59</p>  <p>13x</p> <p>M6 DIN9021</p>	<p>S1</p>  <p>12x</p>		

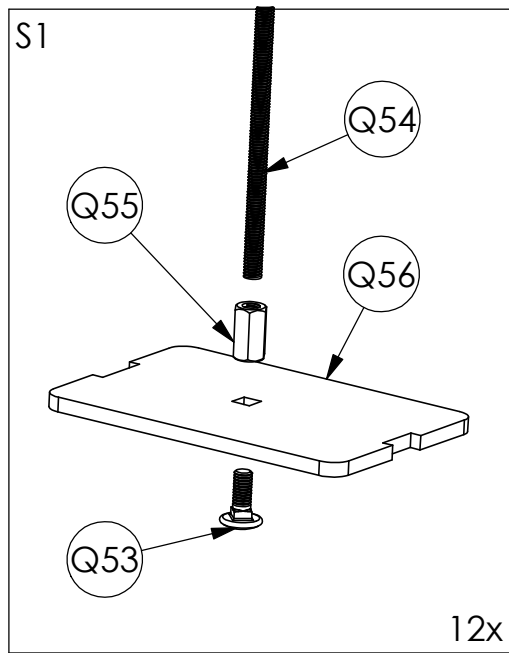
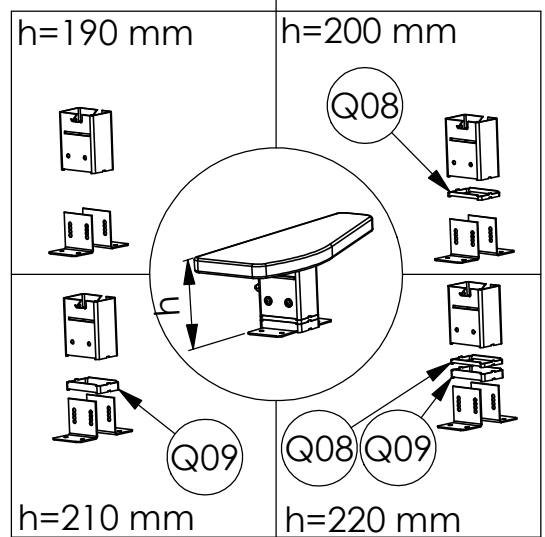
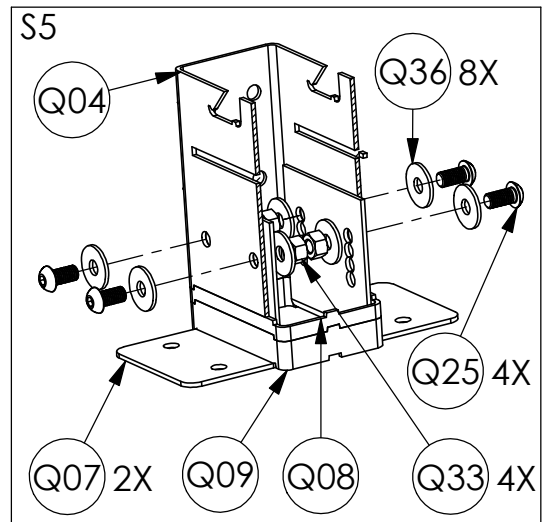
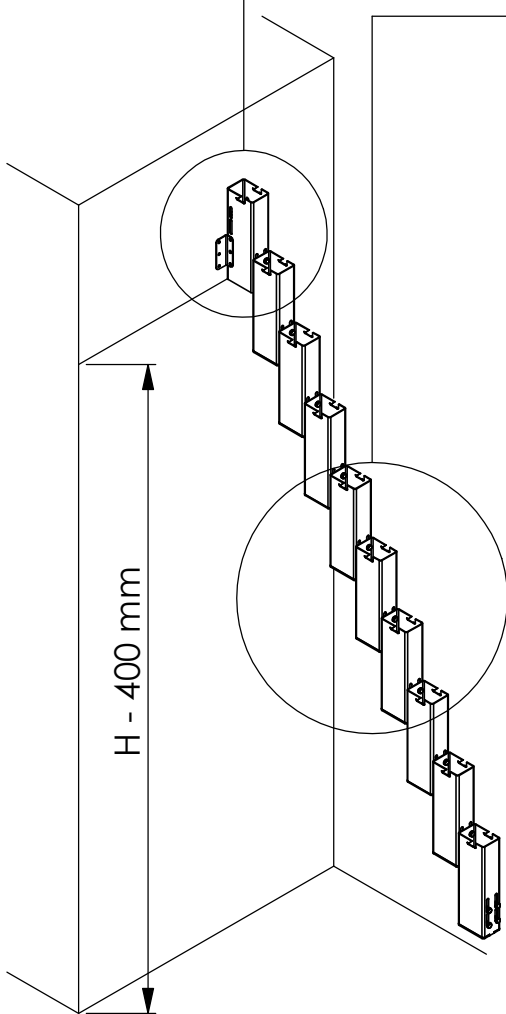
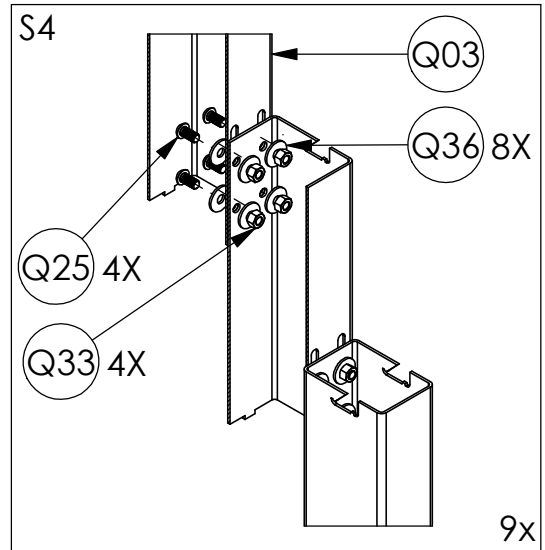
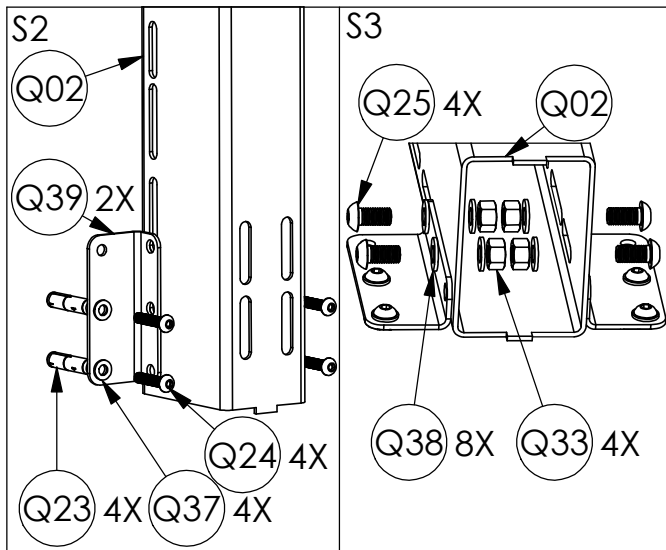

4

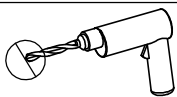

12 mm

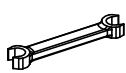

13 mm

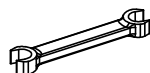

17 mm

S6

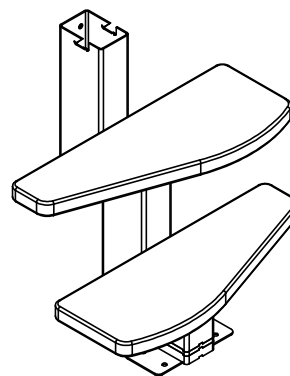
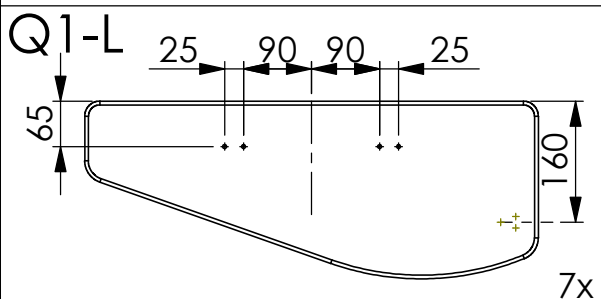
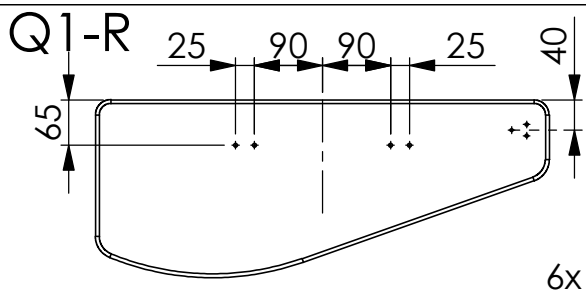
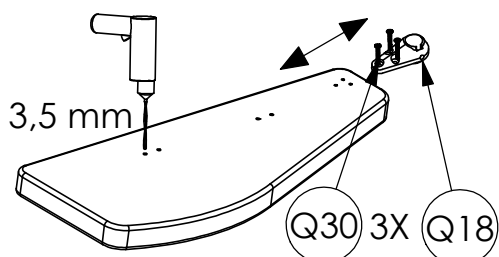

S7

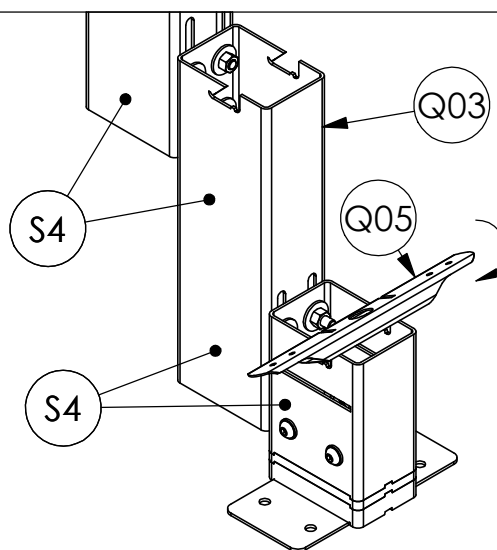

S8

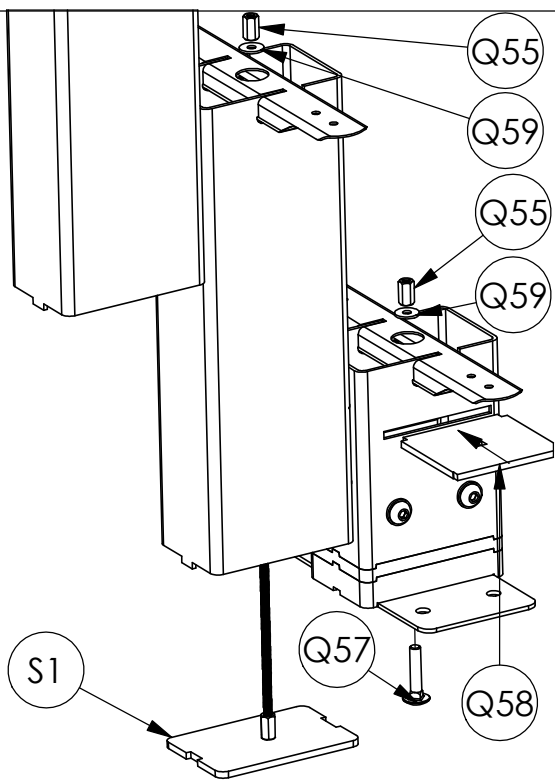

S9

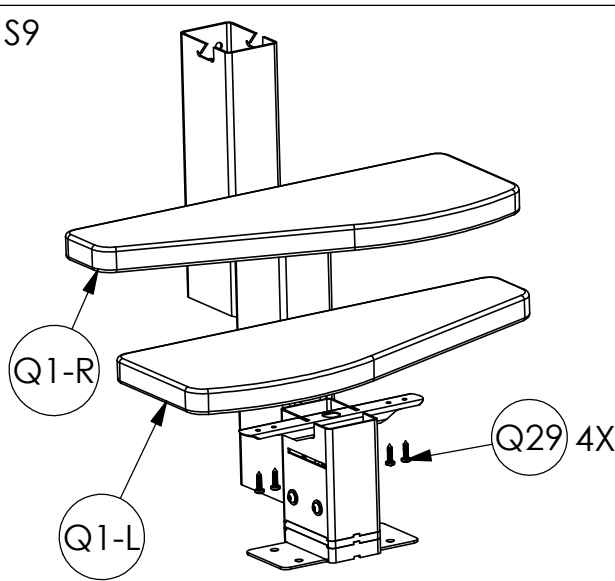

5

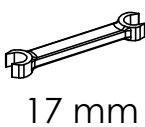
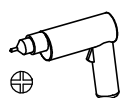
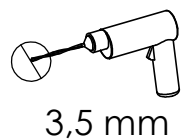

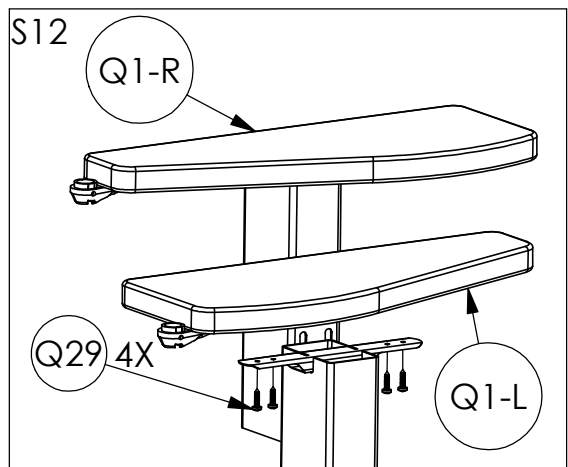
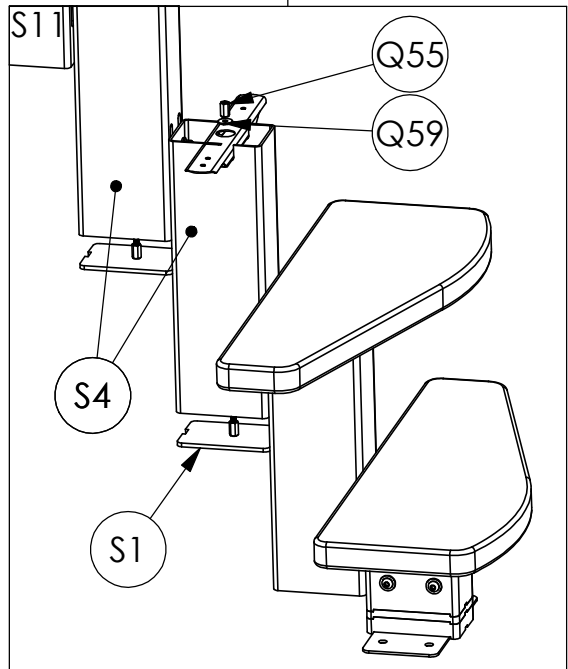
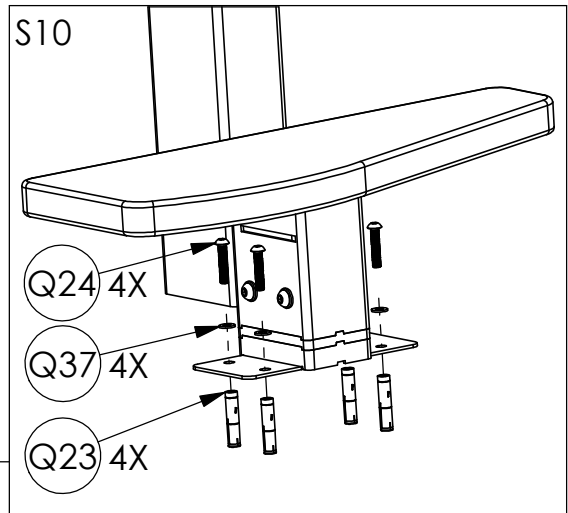
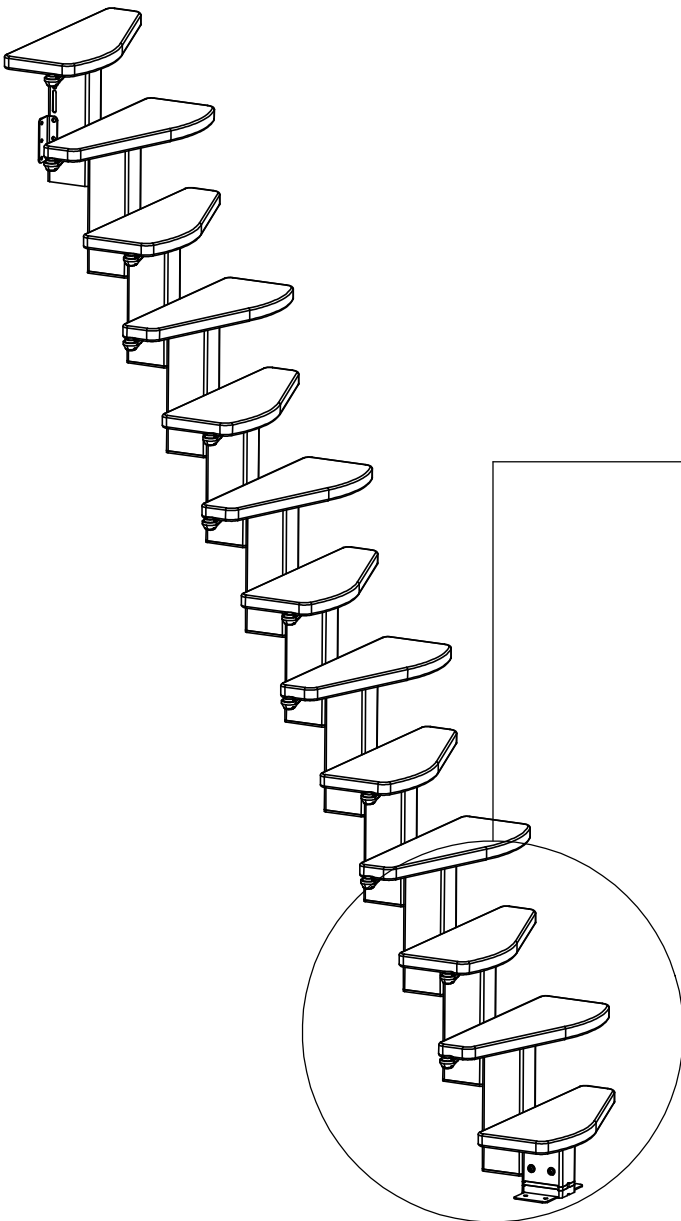

6

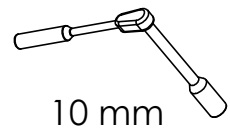
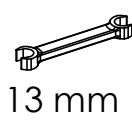
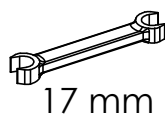
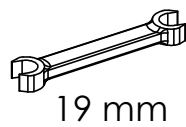
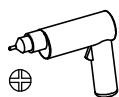
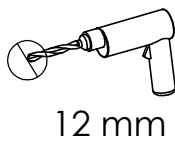

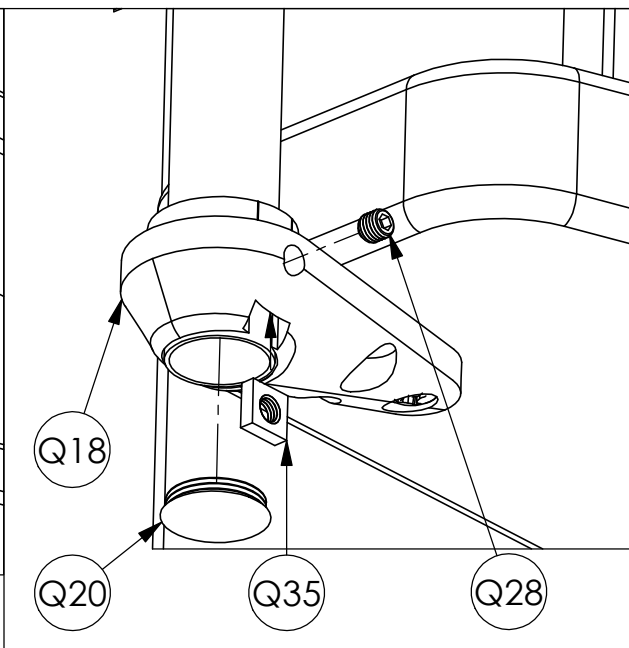
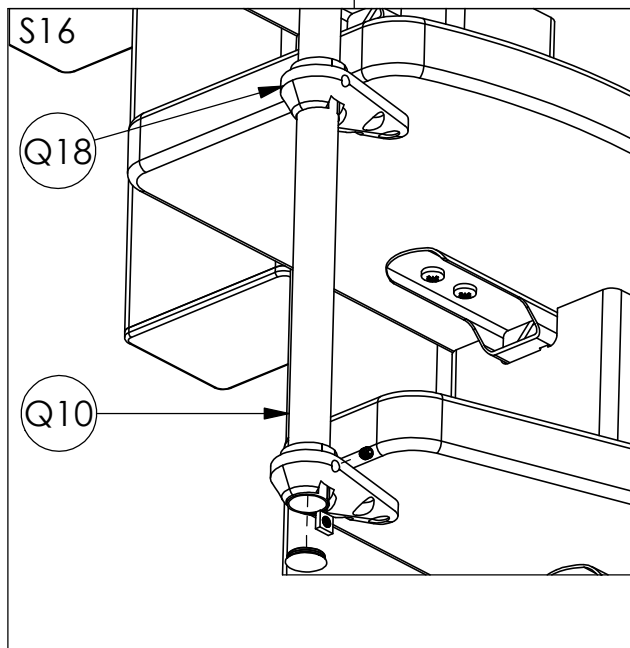
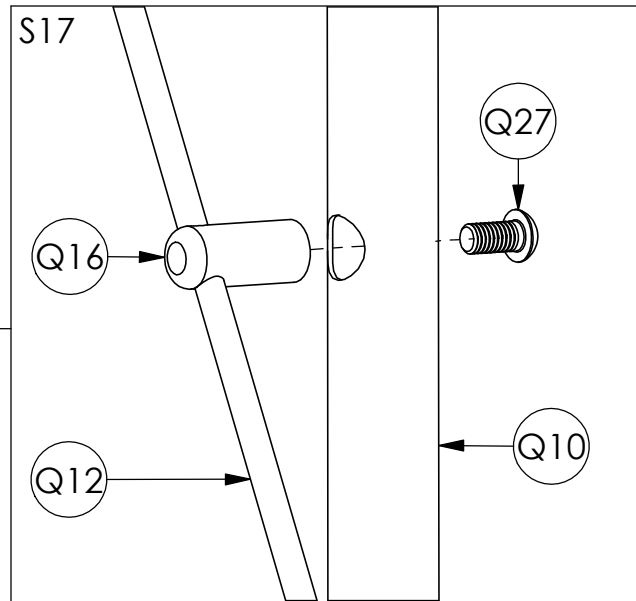
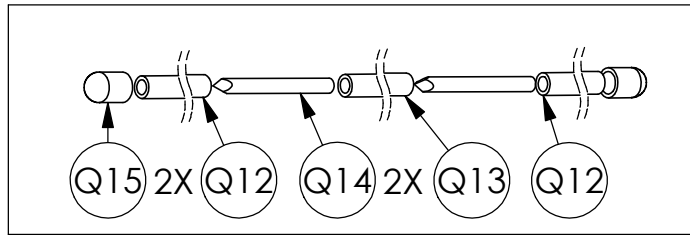
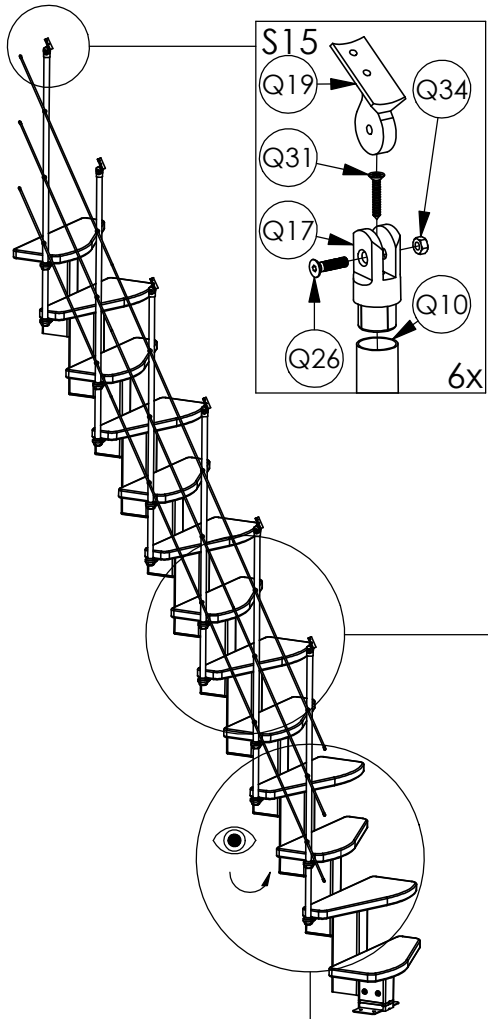

7

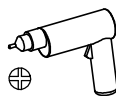
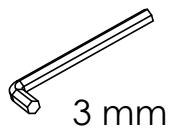
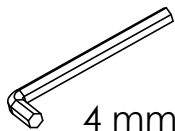

S18

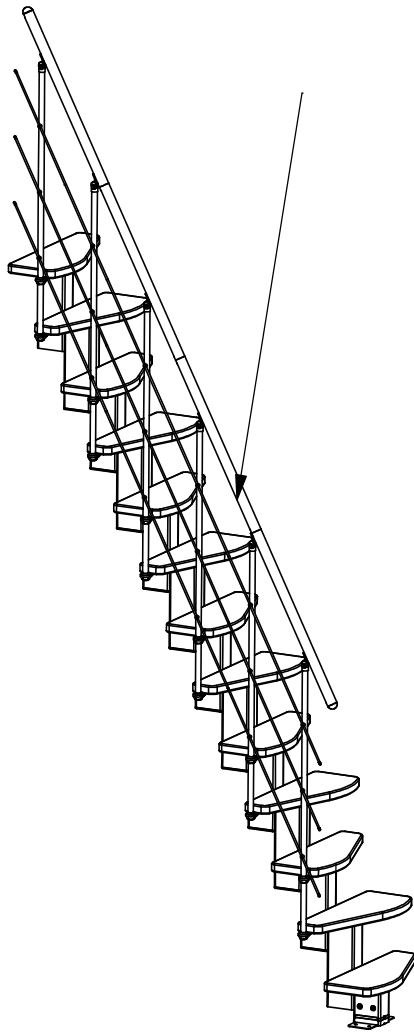
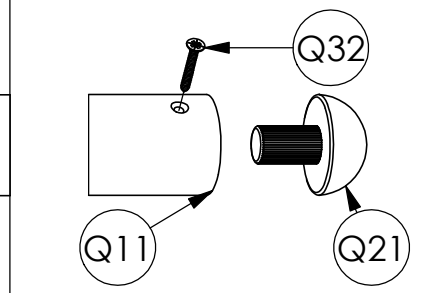
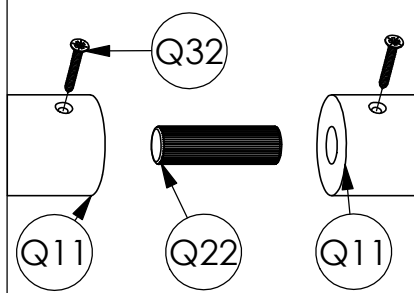
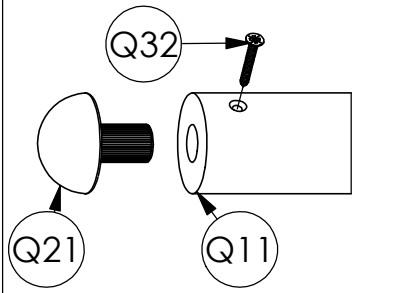
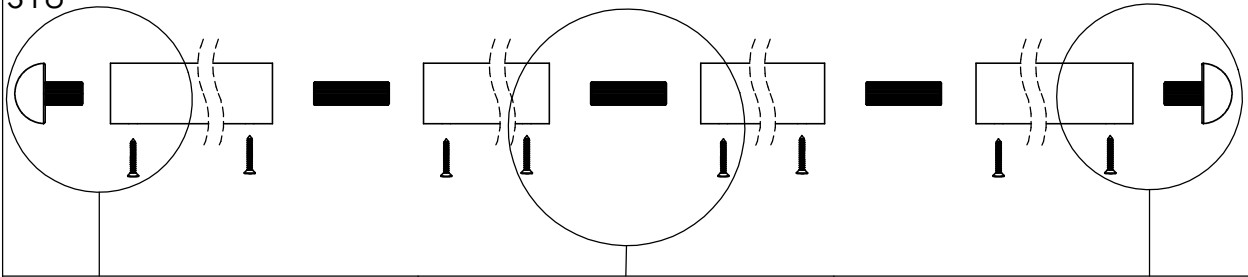

S19

