

# Technische Daten

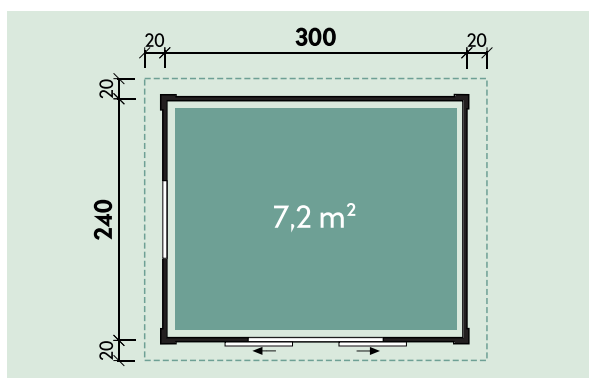

## Artikelnummer:

228 310, 831 321, 831 322, 831 323, 831 324





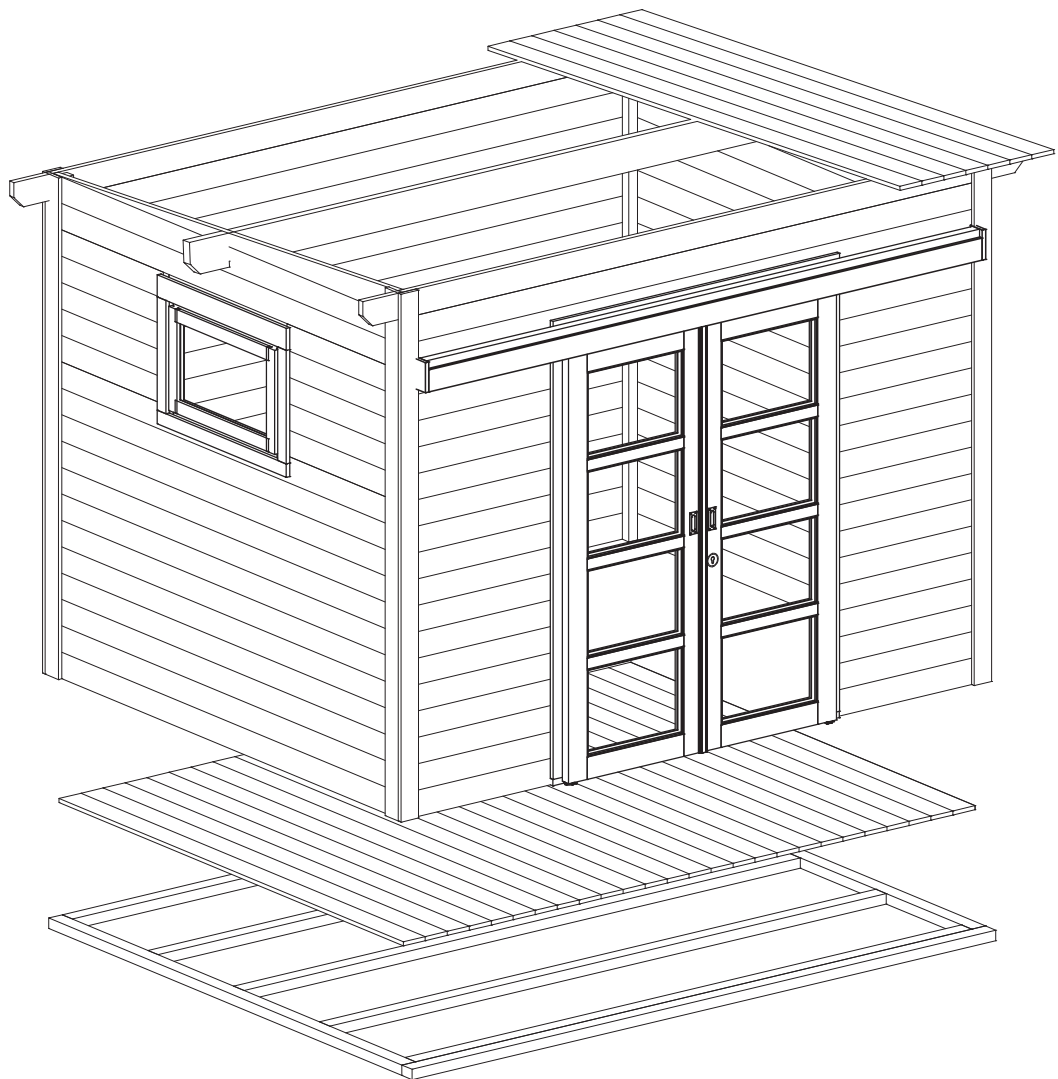

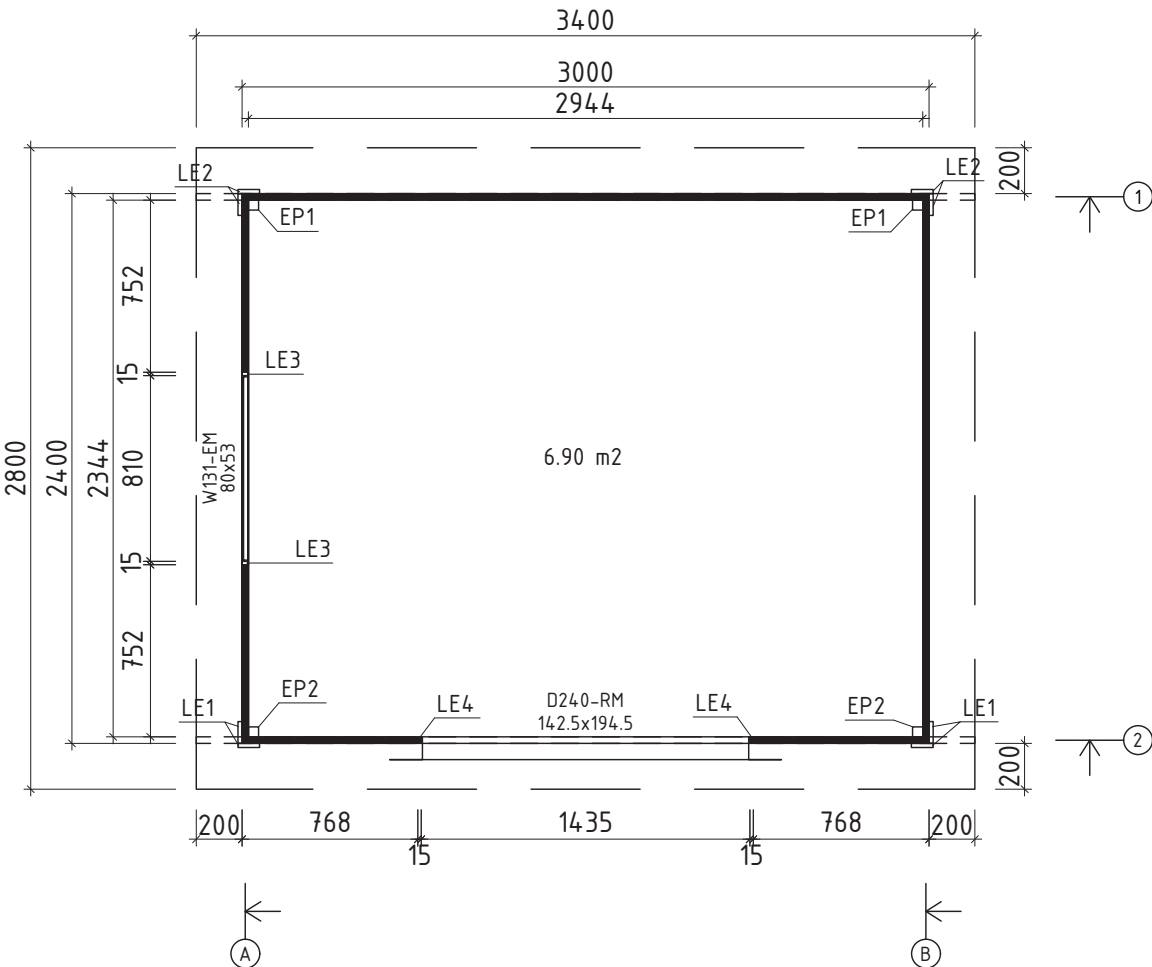



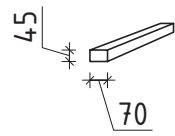
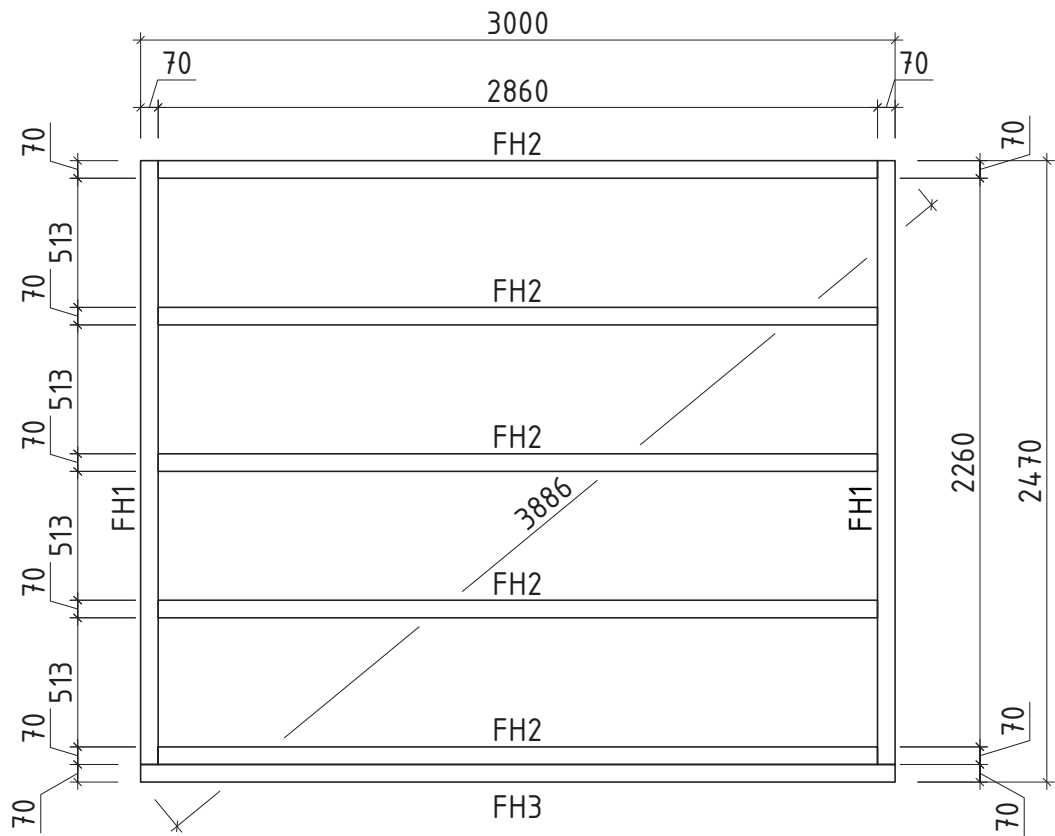





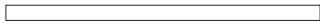

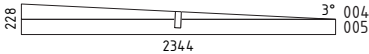
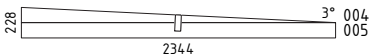

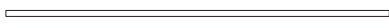



Kontrolliert durch:



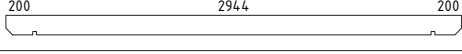
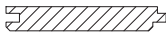
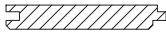



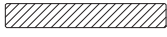





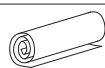

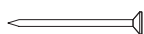

**Q2** – Qualitätsklasse für Fenster und Türen  
 \* Fenster und Türen sind ohne Sprossen

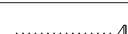

Pos		Stck	Profil (mm)	Länge (mm)
001		2	28x114	3400
002		1	28x114	3000
003		19	28x114	3000
005		31	28x114	2344
006		34	28x114	768
007		10	28x114	752
WA-1		1		
WB-1		1		
FH3	FUNDAMENTHÖLZER (imprägniert) 	1	70x45	3000
FH2	FUNDAMENTHÖLZER (imprägniert) 	5	70x45	2860
FH1	FUNDAMENTHÖLZER (imprägniert) 	2	70x45	2400
LE1	LEISTE 	4	95x18	2280
LE2	LEISTE 	4	95x18	2166
LE4	LEISTE 	2	15x28	1938
LE3	LEISTE 	2	15x28	560
EP2	ECKPFOSTEN 	2	44x44	2270
EP1	ECKPFOSTEN 	2	44x44	2156
PF1	PFETTEN 	1	44x145	3400
	DACHBRETTER 	31+1	113x18	2802
	FUSSBODENBRETTER 	27+1	113x18	2339
	FUSSBODENLEISTEN  ✓		18x40	11,0 lfm
G02-1	GIEBELBRETTER 18x120 	2	18x120	2820
G05-1	GIEBELDECKLEISTEN 18x40  ✓	2	18x40	2820
T02-1	TRAUFENBRETTER 18x120 	1	18x120	3436
T01-1	TRAUFENBRETTER 18x95 	1	18x95	3400

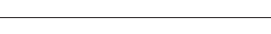
Pos			Stck	Profil (mm)	Länge (mm)
T04-1	TRAUFENDECKLEISTEN 18x40		1	18x40	3436
T06-1	TRAUFENLEISTEN 18x40	 ✓		18x40	7,0 lfm
SH	Schlaghölzer		3		
KP-1	DACHPAPPE	 ✓		3,4m-4st.	14,0 lfm
NG01	DACHPAPPNÄGEL 2.8x15		200		
NG2 550	NÄGEL 2.5x50 Dachbretter		186		
NG2 550	NÄGEL 2.5x50 Fussbodenbretter		270		
SR3 030	SCHRAUBEN 3.0x30 Fussbodenleisten		22		
SR3 030	SCHRAUBEN 3.0x30 Giebeldeckleisten		12		
SR3 030	SCHRAUBEN 3.0x30 Traufenleisten		14		
SR3 545	SCHRAUBEN 3.5x45 Giebelbretter		12		
SR3 545	SCHRAUBEN 3.5x45 Leiste		124		
SR3 545	SCHRAUBEN 3.5x45 Traufenbretter		16		
SR3 545	SCHRAUBEN 3.5x45 Traufendeckleisten		8		
SR44	SCHRAUBEN 4.0x60 Wandbohlen zu Eckpfosten		312		
SR5 0100	SCHRAUBEN 5.0x100 Fundamenthölzer		32		
	✓ - bitte selber anpassen (falls nötig)!				



Pos		Stck	Profil (mm)	Länge (mm)
	<p style="text-align: center;">TÜR 1425x1945 D2-Q28R-LLM-14251945</p> <p style="text-align: center;">Q2 D240-RM 1425</p>	1		
LU-KL-01-1	LU - Cover strip - Deckbrett - Katteliist ukse kohale	1	18x95	3000
LU-OK-01-1	LU - Covering - Endkappen - Otsakatik	2	18x80	130
LU-KT-01-1	LU - Top frame - Obere Rahmenteil - Kandetala	1	44x65	3000
UPL-1	Wind slat - Windleiste - Piluliist  ✓	1	10x35	1855
SR35-16-01	3.5x16RST LU Handle - Handgriff - Käepide	16		
SR35-45-03	3.5x45 Cover strip - Deckbrett - Katteliist ukse kohale	6		
SR35-45-06	3.5x45 Covering - Endkappen - Otsakatik	4		
SR40-16-02	4.0x16 Wind slat - Windleiste - Piluliist	4		
SR42-75-01	4.2x75 Door frames - Türrahmen - Ukselengid	4		
SR50-90-02	5.0x90 Top frame - Obere Rahmenteil - Kandetala	4		
LU-LS	LU - Cylinder lock - Zylinderschloss - Lukusüdamik	1		
LU-KP	LU - Handle - Handgriff - Käepide	4		
LU-LK	LU - Keyhole cover plate - Schlüsselloch Abdeckplatte - Võtmekilp	1		
LU-SK	LU - Rail set - Schienenkompl.- Siinikomplekt	2		



