

# Technische Daten: Art.-Nr.: 870110

Wandaußenmaß: 360 x 360 cm

Bohlenstärke: 70 mm



Durch Kunden farblich behandelt.

Kontrolliert durch:

Achtung: Alle angegebenen Maße sind ca.-Maße!

# 3D-Darstellung und Grundriss 870110

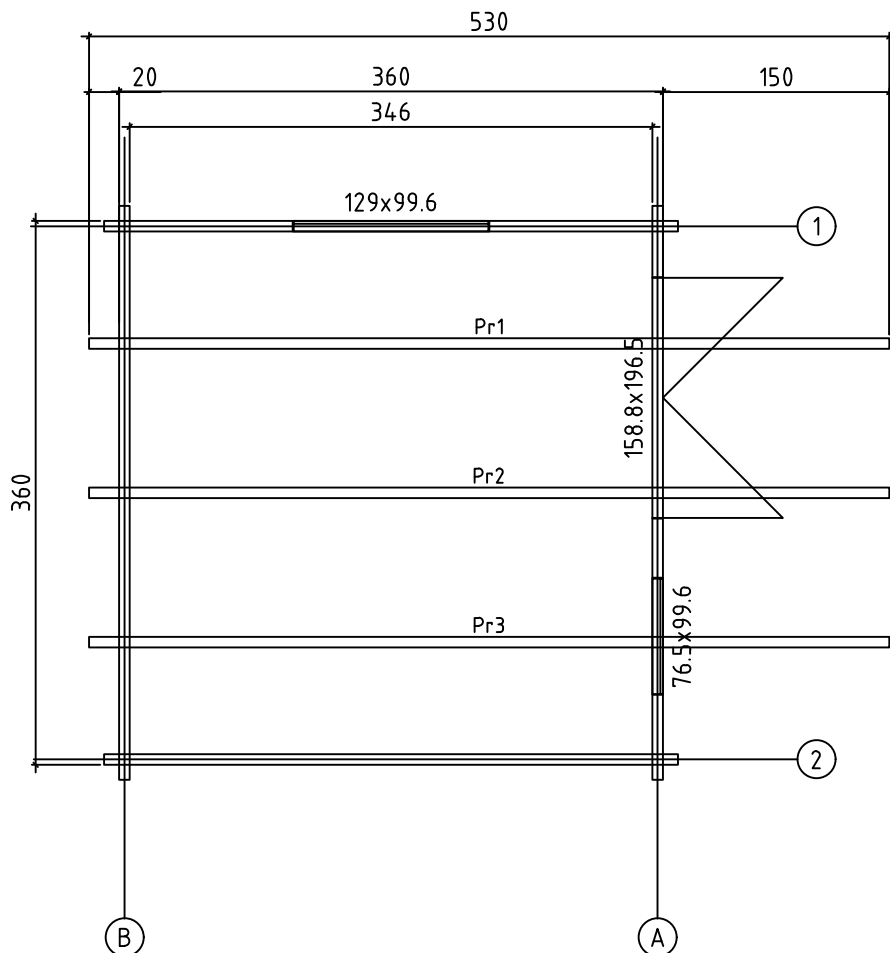
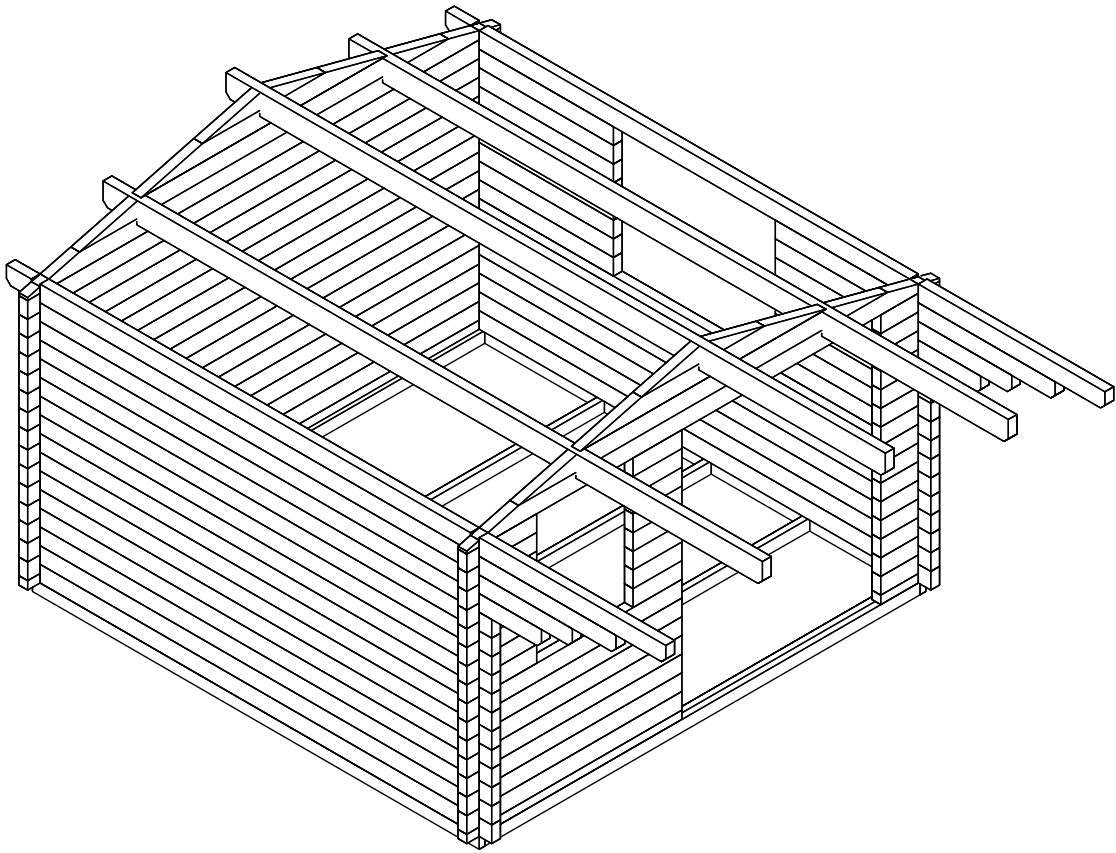





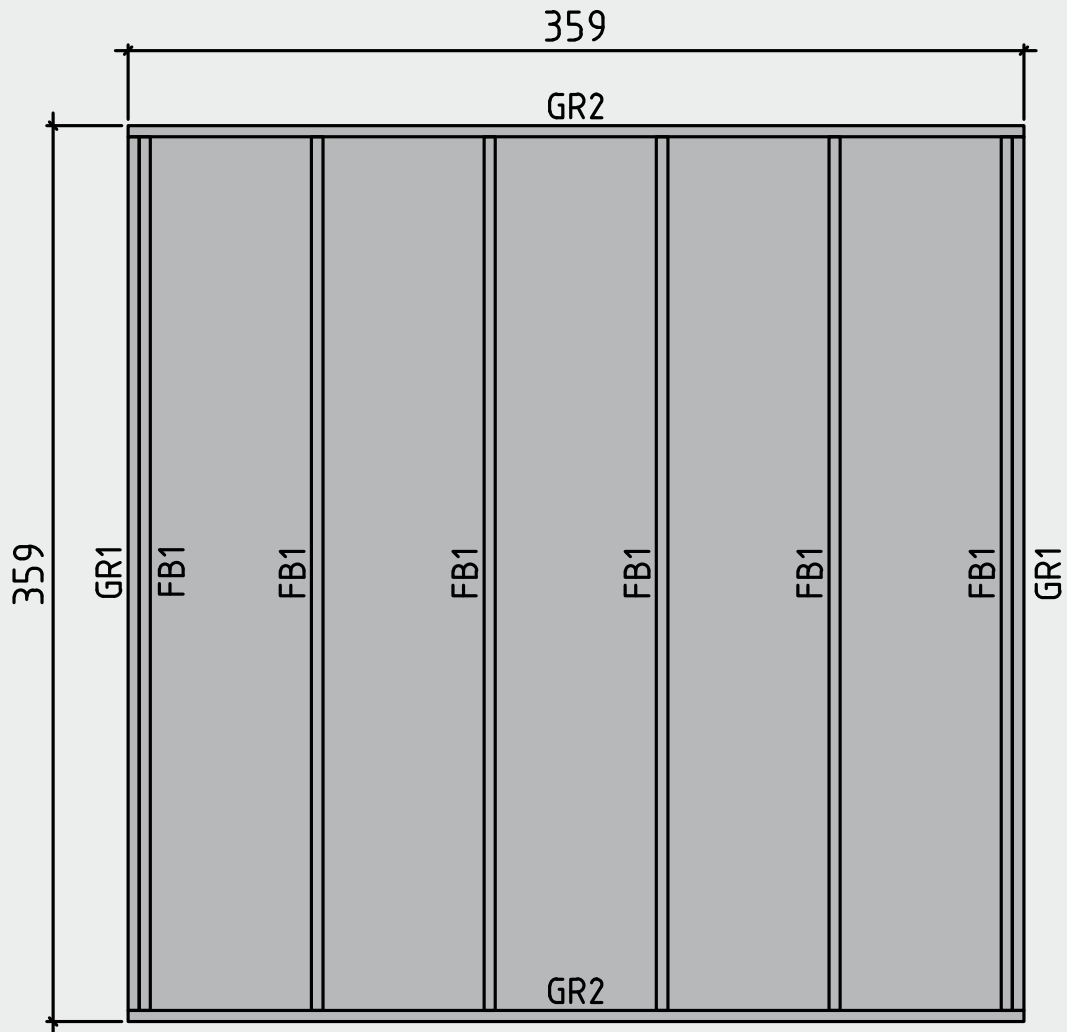





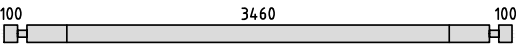
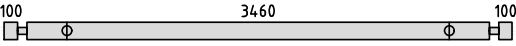
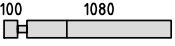

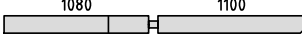

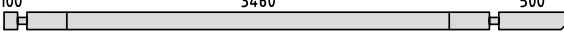
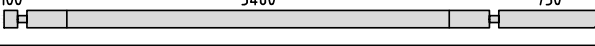
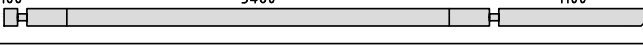
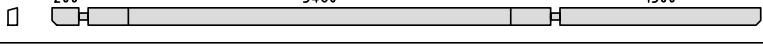
# Lagerholzplan und Fundamentplan 870110

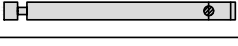
Wir empfehlen als Fundament für Ihr Gartenhaus eine vollflächig festgegründete, gepflasterte oder betonierte Fläche.  
Wahlweise ist auch ein Punkt- oder Streifenfundament möglich.

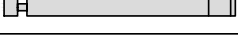

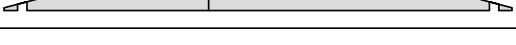

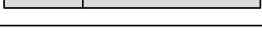
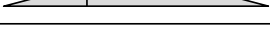

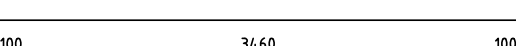
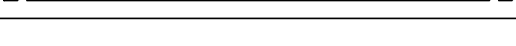





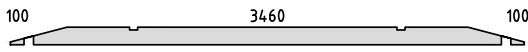

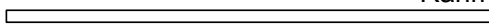
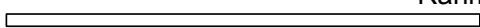

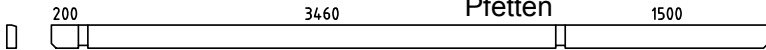
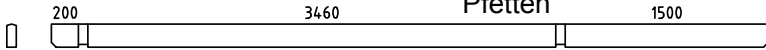
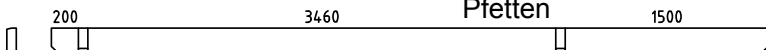
# Teileliste 1

## 870110

| Pos |  | Arv | Profile (mm) | LENGHT (mm) |
|-----|--|-----|--------------|-------------|
| 001 |     | 17  | 70x130       | 3800        |
| 002 |     | 2   | 70x130       | 3800        |
| 003 |     | 13  | 70x130       | 1250        |
| 004 |     | 1   | 70x130       | 1650        |
| 005 |     | 1   | 70x130       | 1900        |
| 006 |     | 1   | 70x130       | 2250        |
| 007 |    | 1   | 70x130       | 5300        |
| 008 |     | 1   | 70x130       | 4200        |
| 009 |     | 1   | 70x130       | 4450        |
| 010 |    | 1   | 70x130       | 4800        |
| 011 |  | 1   | 70x130       | 5300        |
| 012 |   | 1   | 70x65        | 1730        |
| 013 |   | 1   | 70x65        | 472         |
| 014 |   | 1   | 70x130       | 1730        |
| 015 |   | 15  | 70x130       | 472         |
| 016 |   | 6   | 70x130       | 1730        |
| 017 |   | 8   | 70x130       | 563         |
| 018 |   | 8   | 70x130       | 393         |
| 019 |   | 1   | 70x130       | 3800        |
| 020 |   | 7   | 70x122       | 464         |
| 021 |   | 1   | 70x130       | 1917        |
| 022 |   | 1   | 70x130       | 1977        |
| 023 |   | 1   | 70x122       | 464         |
| 024 |   | 1   | 70x65        | 3800        |
| 025 |   | 15  | 70x130       | 3800        |

# Teileliste 2

## 870110

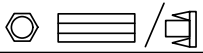
| Pos |   | Arv   | Profile (mm) | LENGTH (mm) |
|-----|---|-------|--------------|-------------|
| 026 |    | 1     | 70x130       | 3800        |
| 027 |    | 1     | 70x130       | 1917        |
| 028 |    | 1     | 70x130       | 1977        |
| GR2 |  Rahmen-Fundamentholz  | 2     | 45x90        | 3590        |
| GR1 |  Rahmen-Fundamentholz  | 2     | 45x90        | 3500        |
| FB1 |  Fundamentholz   | 6     | 45x90        | 3500        |
| Pr1 |  Pfetten  | 1     | 70x170       | 5300        |
| Pr2 |  Pfetten  | 1     | 70x170       | 5300        |
| Pr3 |  Pfetten  | 1     | 70x170       | 5300        |
|     | Fenster 1290x996  | 1     |              |             |
|     | Fenster 765x996   | 1     |              |             |
|     | Tür 1588x1965   | 1     |              |             |
| 1   | Screws/Schrauben/Vis 5x100 mm- For fixing first row of wall logs<br>/Fixierung des ersten Bohlenkranzes/Pour fixer les lames de plancher    | 6     |              |             |
| 2   | Nails/Nägel/Clous 2.5x50 - For fixing floorboards/<br>Befestigung Fussbodenbretter/Pour fixer les lames de plancher    | 280   |              |             |
| 3   | Nails/Nägel/Clous 2.5x50 - For fixing roofboards/<br>Befestigung Dachbretter/Pour fixer les voliges    | 370   |              |             |
| 4   | Nails/Nägel/Clous 2.5x50 - For fixing floor edge trims/<br>Befestigung Fussleisten/Pour fixer les plinthes du plancher   | 30    |              |             |
| 5   | Nails/Nägel/Clous 2.5x50 - For fixing roofing felt fillet/<br>Befestigung giebelabschlussbrett/Pour fixer la latte de finition de la couverture    | 20    |              |             |
| 6   | Screws/Schrauben/Vis 2,5x50 mm- For fixing roof side boards and roof edge reinforcement<br>Befestigung Traufenbretter und Traufenleisten<br>Pour fixer les planches de rive et le tasseau de refront  | 44    |              |             |
| 7   | Screws/Schrauben/Vis 2,5x50 mm- For fixing fascia boards and diamonds/<br>Befestigung Giebelblende und Raute<br>Pour fixer les planches de rive et le diamant   | 28    |              |             |
| 8   | Screws/Schrauben/Vis 2,5x50 mm- For fixing fwindow and door trims/<br>Befestigung Fenster und türen/<br>Pour fixer les croisillons des fenetres et des portes   | 44    |              |             |
| 9   | Metal storm Brace/Gewindestange/Tige filetee 8 mm   | 5     |              |             |
| 10  | Shim,Nuts/Mutter ,U-Scheibe/Ecrou;Rondelle 8 mm<br>For fixing storm braces/ Pour fixer les anti tempete/ Für Sturmleisten<br>Pour fixer les croisillons des fenetres et des portes                    | 5 / 5 |              |             |
|     | Metal storm Brace/Gewindestange/Tige filetee 8 mm<br>KL1 M8 2,63 m 4 Screws 180 10 pcs.<br>KL2 M8 2,51 m 1 Plastic caps 5 pcs.  |       |              |             |

# Wandpläne 1 und 2

## 870110

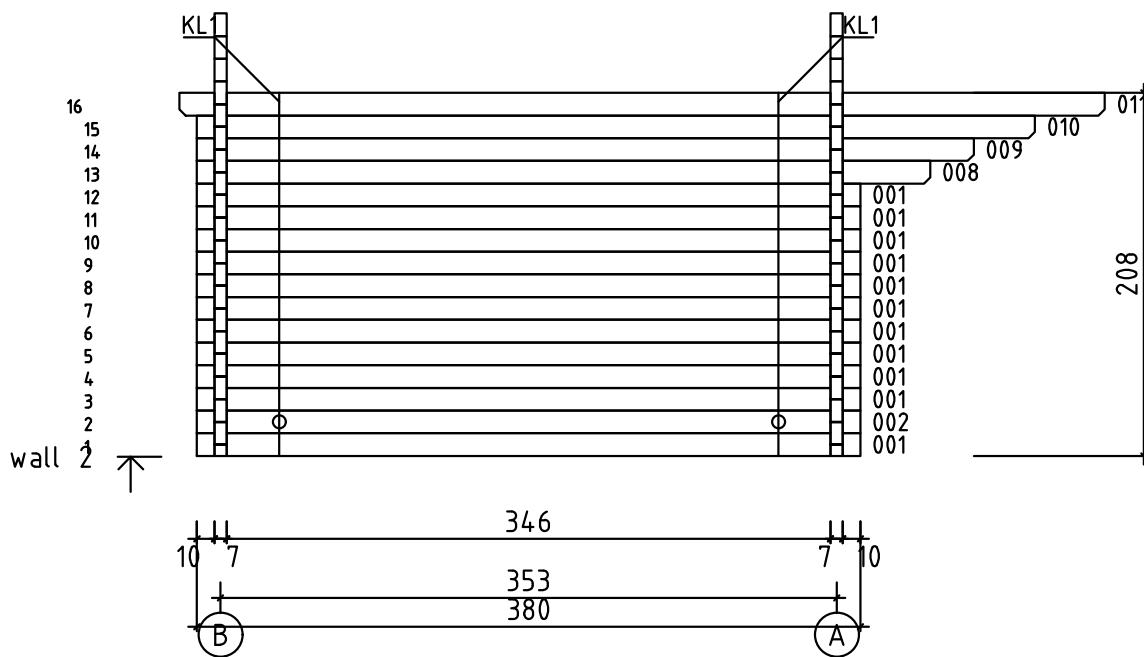
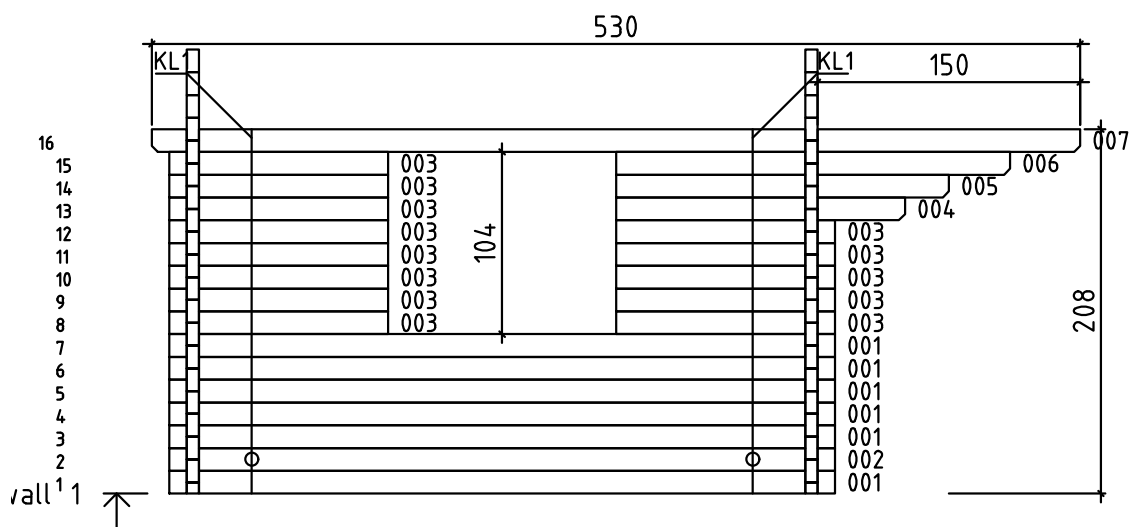

# Wandpläne A und B 870110

