

Technische Daten: Art.-Nr.: 540487

Wandaußenmaß: 370 x 290 cm

Bohlenstärke: 40 mm



Farbbehandlung: Natur

Kontrolliert durch:

Achtung: Alle angegebenen Maße sind ca.-Maße!

3D-Ansicht 540487

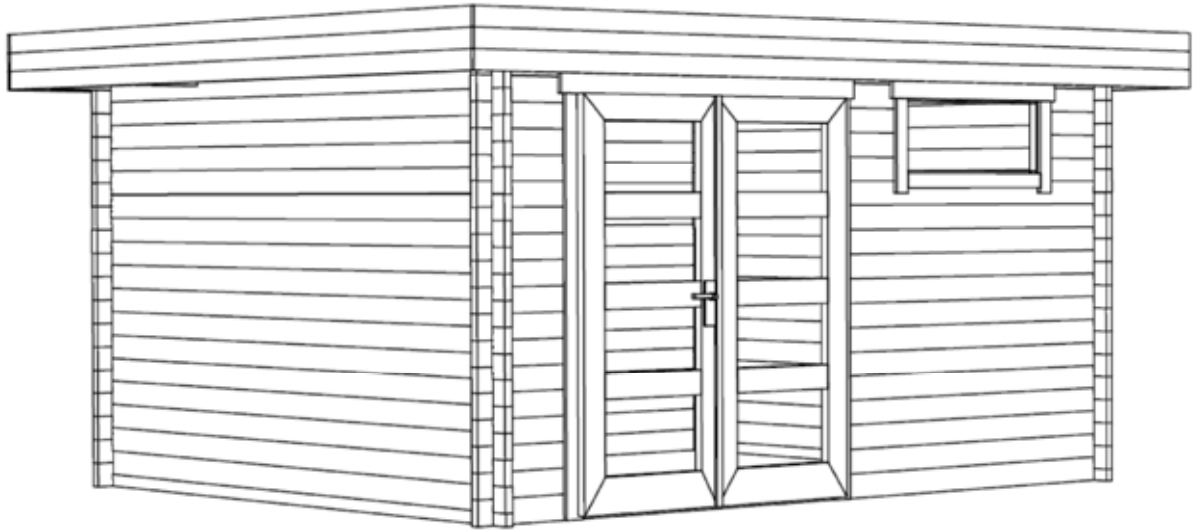

Grundriss 540487

Groundplan - Grundplan - Plan de masse - Planimetria -
Plattegrond - Pöhiplan

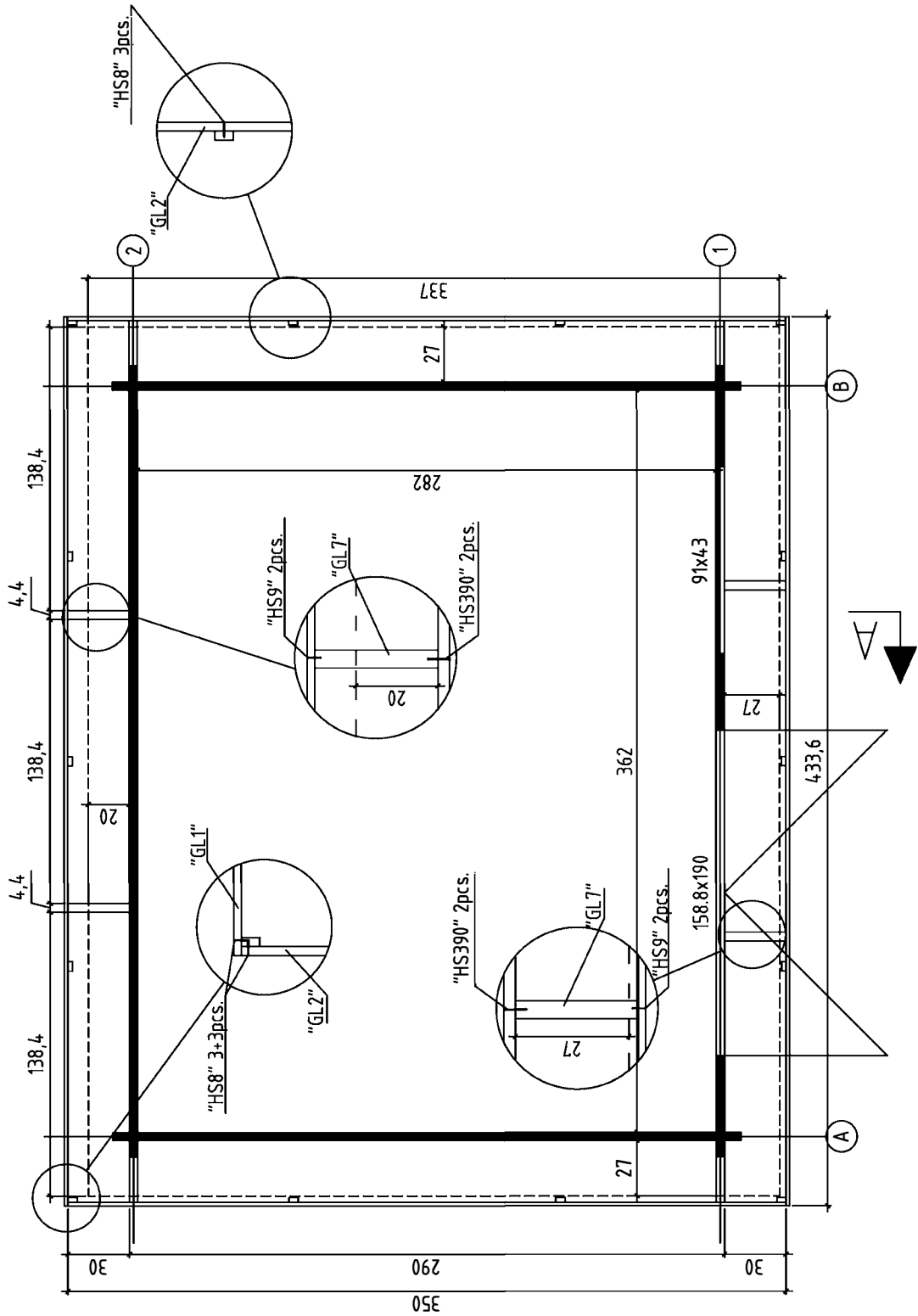





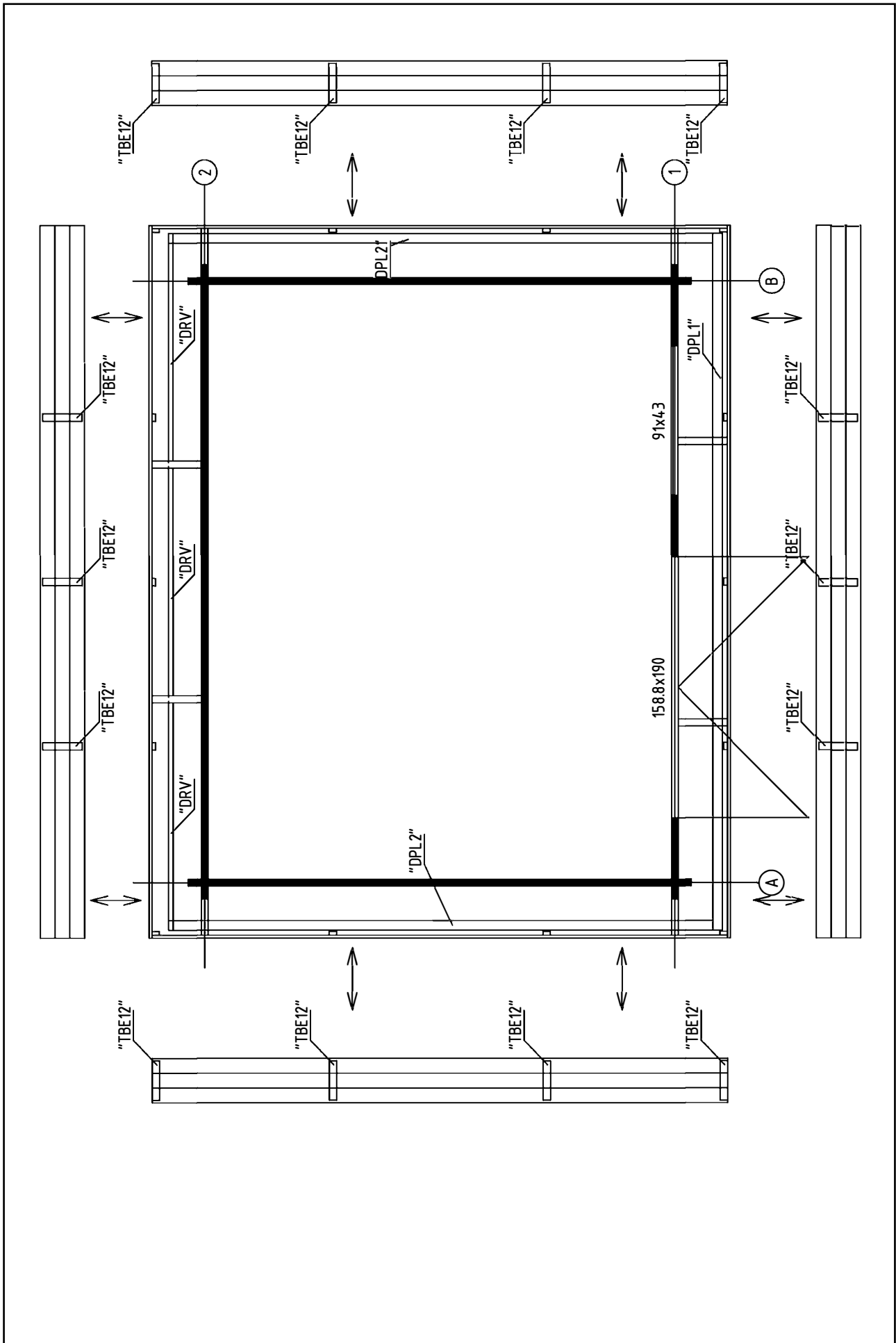





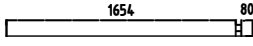

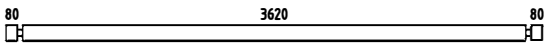
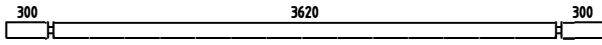
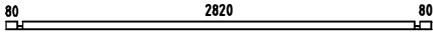
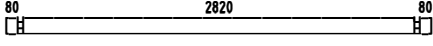
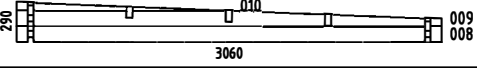
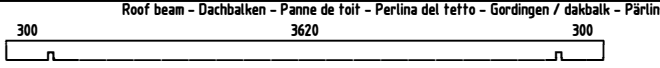
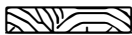
Dach-Draufsicht

540487



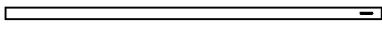
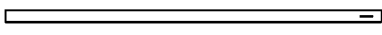

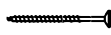
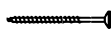

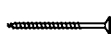

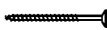

Teileliste 1

540487

Pos			P (mm)	L (mm)	
001			21	40x114	490
002			13	40x114	1774
003			4	40x114	366
004			18	40x114	3860
005			2	40x114	4300
006			2	40x57	3060
007			32	40x114	3060
WA-1 WB-1			1 1		
PR21			3	44x140	4300
GL1	Gable moulding - Giebelleiste - Planche de rive - Finitura per frontale e retro del tetto - Gevellijst - Viilulaud 		6	18x90	4336
GL2	Gable moulding - Giebelleiste - Planche de rive - Finitura per frontale e retro del tetto - Gevellijst - Viilulaud 		6	18x90	3500
DPL1	Roofing felt fillet - Dachpappenleiste - Baguette de fixation du feutre bitumeux - Asse per fissaggio guaina bituminosa - Afdekljst asfaltpapier - Katusepapiiist 		1	58x18	4240
DPL2	Roofing felt fillet - Dachpappenleiste - Baguette de fixation du feutre bitumeux - Asse per fissaggio guaina bituminosa - Afdekljst asfaltpapier - Katusepapiiist 		2	58x18	3312
DB	Roof boards - Dachbretter - Voliges - Perlina per tetto - Dakhout - Kafuselaud 		48	90x18	3373
DRV	Roof edge reinforcement - Dachrandverstärkung - Corniere de renfort de bord de toit - Rinforzo x tetto - Dakrand versterking - Räästafugevdus 		3	28x34	1384
KFS-1	Storm protection - Sturmleiste - Latte anti-tempete - Protezione anti vento - Stormverankering / beveiliging - Tormikinnitusliist 		2	22x45	2050
KFS-2	Storm protection - Sturmleiste - Latte anti-tempete - Protezione anti vento - Stormverankering / beveiliging - Tormikinnitusliist 		2	22x45	2500
GL7	Distance spacers for gable moulding - Dachstützen - Supports extension toiture - Distanziatori per la modanatura del timpano - Daksteun / afstand houder - Viilulaudade distantsklots 		4	44x120	305
TBE12	Fixing slat for distance spacers - Befestigungsleiste - Renforts planches de rives - Stecca per fissare i distanziatori - Bevestigingslat afstandhouders - Viilulaua kinnitus 		14	22x45	240
HS8	Screw for gable moulding - Schrauben für giebelleiste - Vis pour fixation planche de rive - Vite per fissare finiture davanti e dietro del tetto - Schroef voor gevellijst - Krugi viilulauale 		54	3.5x35	
HS9	Screw for gable moulding - Schrauben für giebelleiste - Vis pour fixation planche de rive - Vite per fissare finiture davanti e dietro del tetto - Schroef voor gevellijst - Krugi viilulauale 		16	3.5x50	
HS12	Screw for roof edge reinforcement - Schrauben für dachrandverstärkung - Vis pour fixation corniere renfort de bord de toit - Viti x rinforzo bordo tetto - Schroef voor dakrand versterking - Krugi räästafugevdusele 		9	4x40	
HS18	Screw for roof beams - Schrauben für dachbalken - Vis pour fixation pannes de toit - Viti per perline del tetto - Schroef voor gordingen / dakbalken - Krugi pärlinitele 		6	5x120	

Teileliste 2

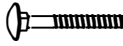
540487



Pos			P (mm)	L (mm)
HS18	Screw for gable - Schrauben für giebel - Vis pour fixation des pignons - Viti per timpano - Schroef voor gevelpunt - Kruvi viilude kinnitamiseks		8	5x120
HS390	Screw for fixing gable moulding distance spacers to the wall - Schrauben für dachstützen - Vis de supports extension toiture - Viti x fissaggio fascioni - Schroef voor bevestiging gevelpunt afstandhouder tot wand - Kruvi viilulaudade distantisklotsi kinnitamiseks seinale		8	5x90
SH40	Hammer block - Schlagholz - Calle de frappe - Blocco di legno da usare come cuscinetto quando si usa il martello - Slagklos - Löögiklots		1	
SFS	Nut for storm protection - Schraubenmutter für sturmleiste - Ecrou pour latte anti-tempete - Dado x asta protezione vento - Moer voor stromverankering - Mutter tormikinnitusliistule		8	D6
NF4	Zn nail for roof - Zn nägel für dachbretter - Pointe pour fixation voliges de toit - Chiodi x pertine tetto - Spijker(nagel) voor dakhout - Nael katuselauale		245	2x50
NF5	Zn nail for roofing felt fillet - Zn nägel für dachpappenleiste - Pointe pour baguette de fixation feutre bitumeux - Chiodi x carta bituminosa x tetto - Spijker(nagel) voor asfaltpapier afdeklijst - Papiliistunael		32	2x40
BFS	Bolt for storm protection - Bolzen für sturmleiste - Boulon pour latte anti-tempete - Bullone x asta protezione vento - Bout voor stormankerlat - Puidupolt tormikinnitusliistule		8	6x70
DFS	Washer for storm protection - Dichtscheibe für sturmleiste - Rondelle pour latte anti-tempete - Rondella x asta protezione vento - Afdichtring voor storm strip - Seib tormikinnitusliistule		8	D6
	Window - Fenster - Fenetre - Finestra - Raam - Aken	910x430 AK.1.100.MSV.f MGC	1	
	Door - Tür - Porte - Porte - Deur - Uks	1588x1900 TUK.4.020.MVV.MMb MGC	1	

Fensterdetails 540487

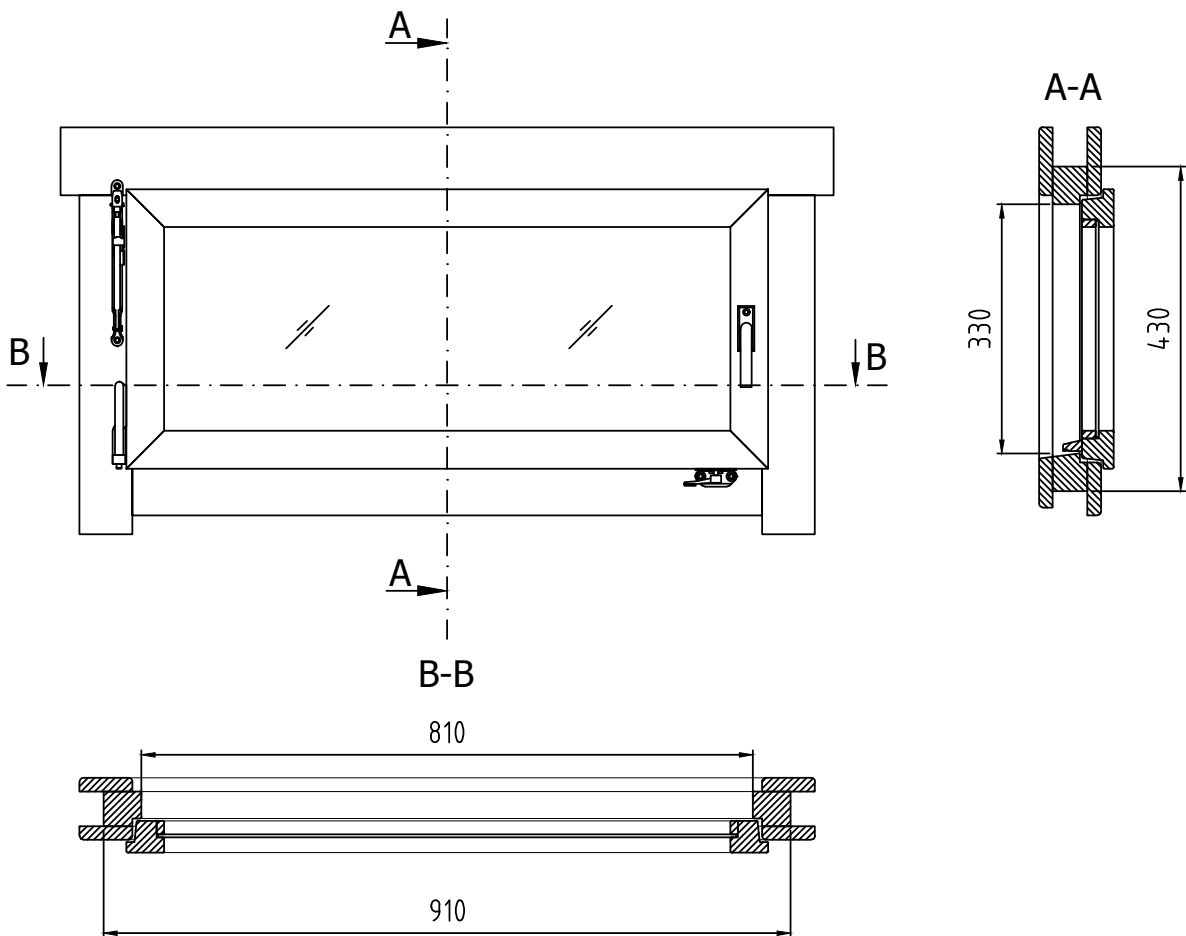
Milklass size - Milchglasgröße - Taille de la vitre - Misura del vetro -
Glas afmeting - Klaasi mõõt: 766x286 mm

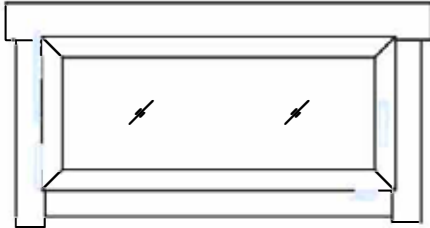
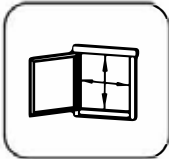

Teileliste Fenster 540487

Pos		P (mm)	L (mm)
	<p data-bbox="272 353 1182 383">Glass size - Glasgröße - Taille de la vitre - Misura del vetro - Glas afmeting - Klaasi mõõt: 766x286 mm</p> <div data-bbox="580 436 1011 663" style="text-align: center;">  </div> <div data-bbox="1225 353 1394 510" style="text-align: right;">  </div> <p data-bbox="1257 528 1362 557" style="text-align: right;">810x330 mm</p>		
FS1	<p data-bbox="272 2018 948 2067">Window handle fittings - Fenstergriff - Poignee de fenetre - Maniglia c/ferramenta - Raamhendel -/grendel -/klink - Aknalink</p> <div data-bbox="1075 2011 1158 2078" style="text-align: right;">  </div>	1	
FSP	<p data-bbox="272 2085 1023 2157">Bolt for window handle fittings - Bolzen für fenstergriff beschlag - Vis pour fixation poignee de fenetre - Bullone x apertura manuale finestra - Schroef voor raamhendel - Akna käepideme polt</p> <div data-bbox="1038 2101 1158 2145" style="text-align: right;">  </div>	2	







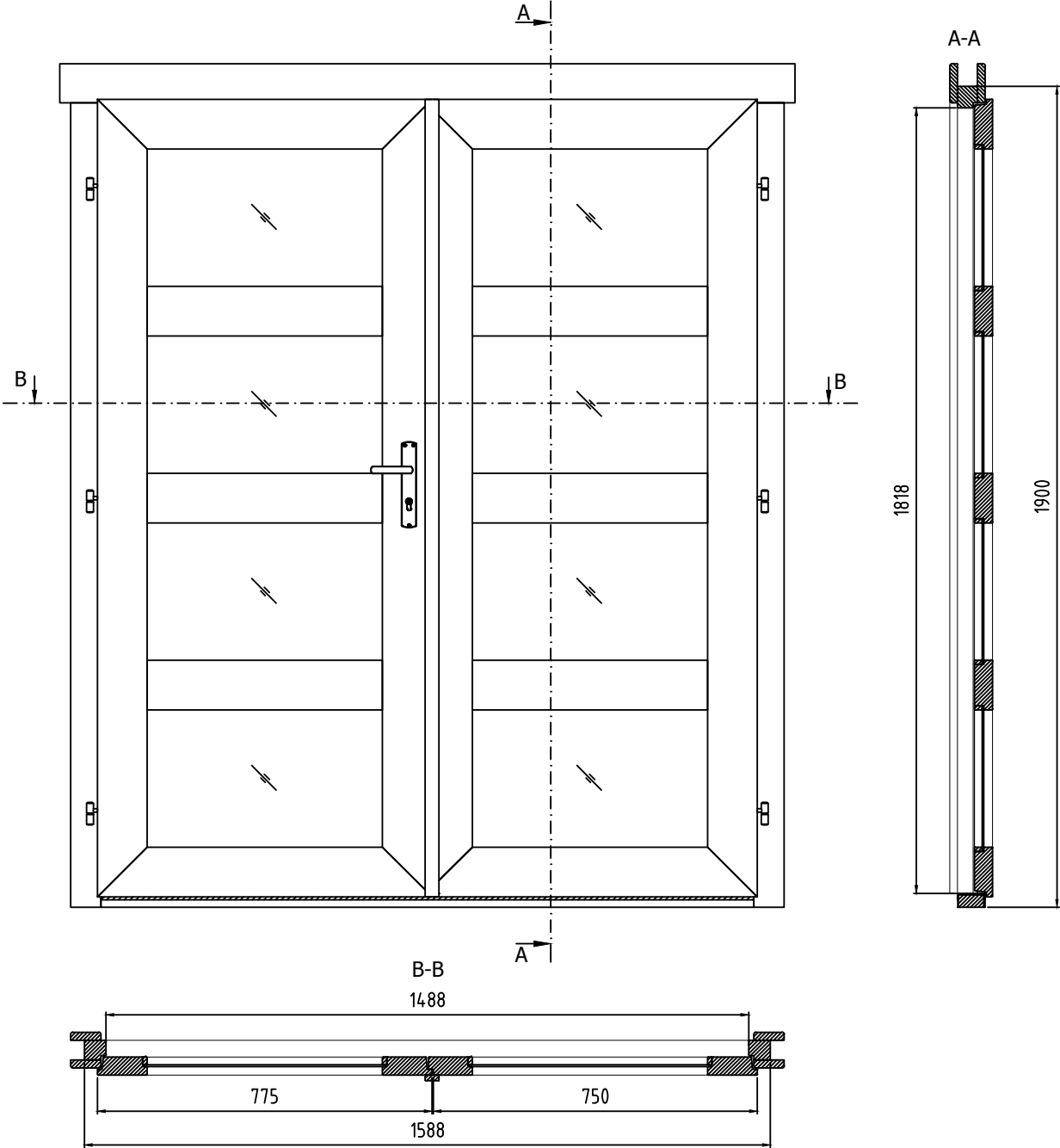

Türdetails

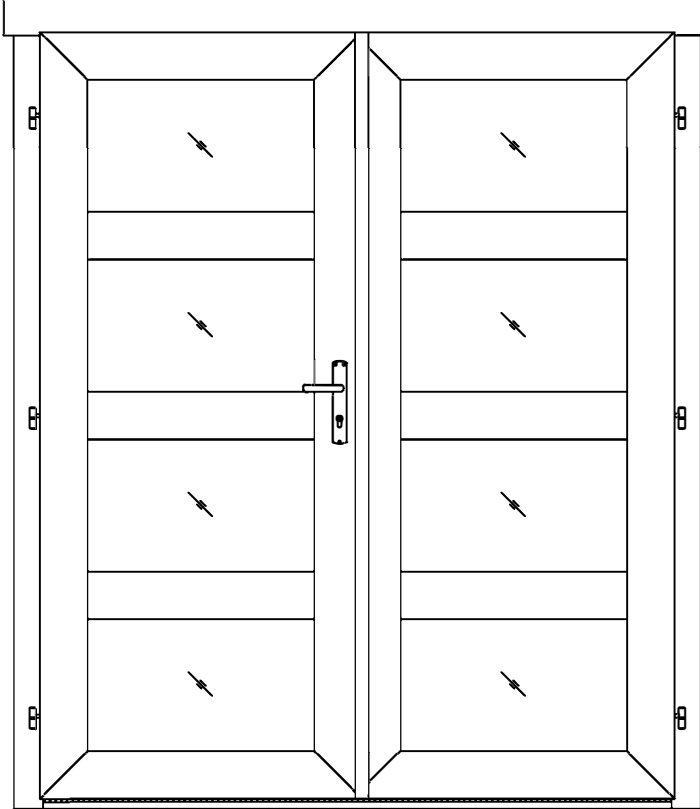
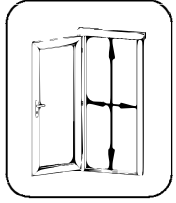
540487

Milclass size - Milchglasgröße - Taille de la vitre - Misura del vetro -
Glas afmeting - Klaasi mõõt: 561x334 mm

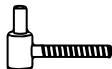

Teileliste Tür 540487

Pos		P (mm)	L (mm)	
	<p>Glass size - Glasgröße - Taille de la vitre - Misura del vetro - Glas afmeting - Klaasi mõõt: 561x334 mm</p>   <p>1488x1818 mm</p>			
HS4	Screw for door fillet - Schraube zur Befestigung Türleiste - Vis pour fixation baguette d'arrêt de porte - Viti per massellino della porta - Schroef voor deurlijst - Kruvi ukse kokkuvaltssiliistule		5	3x30
HS16	Screw for door jamb - Schraube für Türrahmen - Vis de fixation partie haute avec montants du cadre de porte - Viti x fissaggio montanti porte - Schroef voor deurkozijn - Kruvi ukse lengile		4	5x90
HS25	Screw for doorstep - Schrauben für Swelle - Vis pour fixation barre de seuil - Vite per soglia della porta - Schroef voor deurdorpel - Kruvi lävepakule		3	4.5x65
TL4	Door handle fittings - Türgriff - Poignée de porte - Maniglie - Deurhendel / klink - Ukse käepide		1	
TL5	Set of door lock covers - Schlossblenden - Set de garnitures de porte - Copertura serrature - Slot sluitplaat set - Ukse lukuplaat		1	
	Cylinder lock - Zylinderschloss - Barillet de porte - Serratura - Cylinder slot - Ukse lukusüdamik		1	30x35
	Male bolt hinge for door - Türband - Partie male de paumelle de porte - Cerniera anube x porta - Scharnier bout - Ukse polthing isane		6	
	Striker for barrel bolt - Hülse für Grendelriegel - Gache au sol du targette - Boccola per fermo della porta - Huls voor vergrendelingsschuif - Vasturaud ukse servariivile		2	

Wandplan 1 und 2

540487

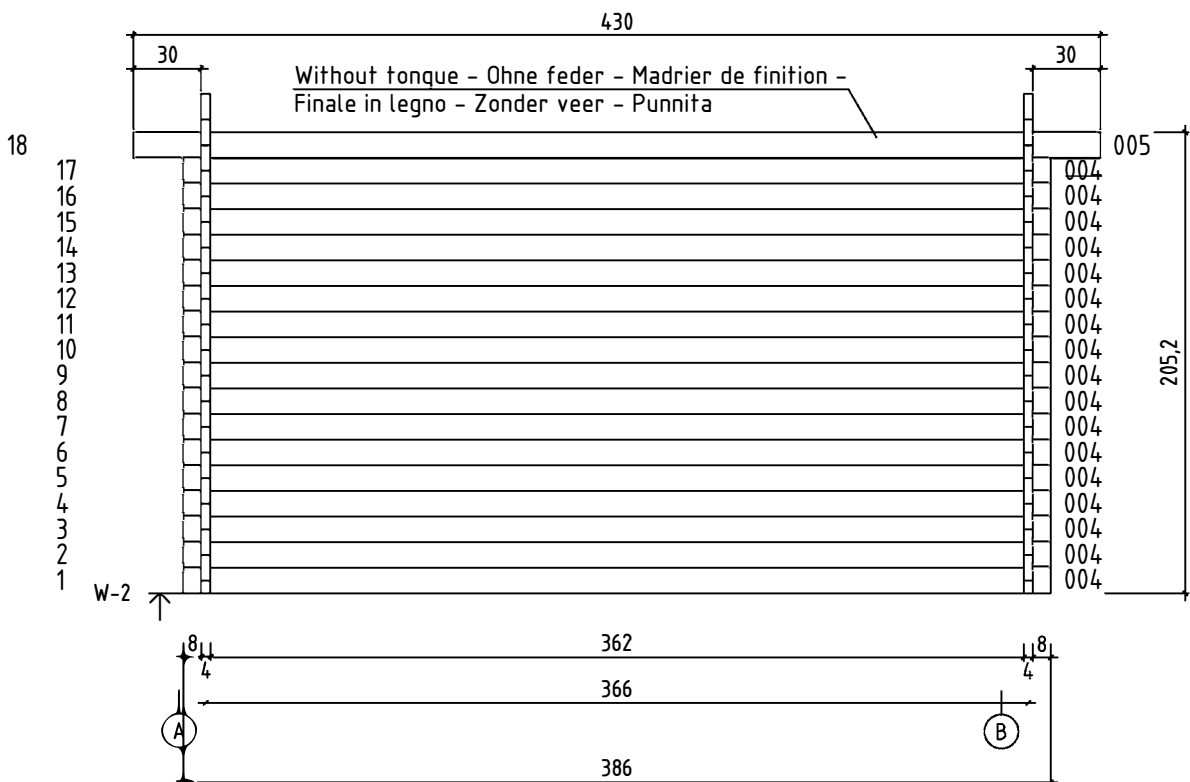
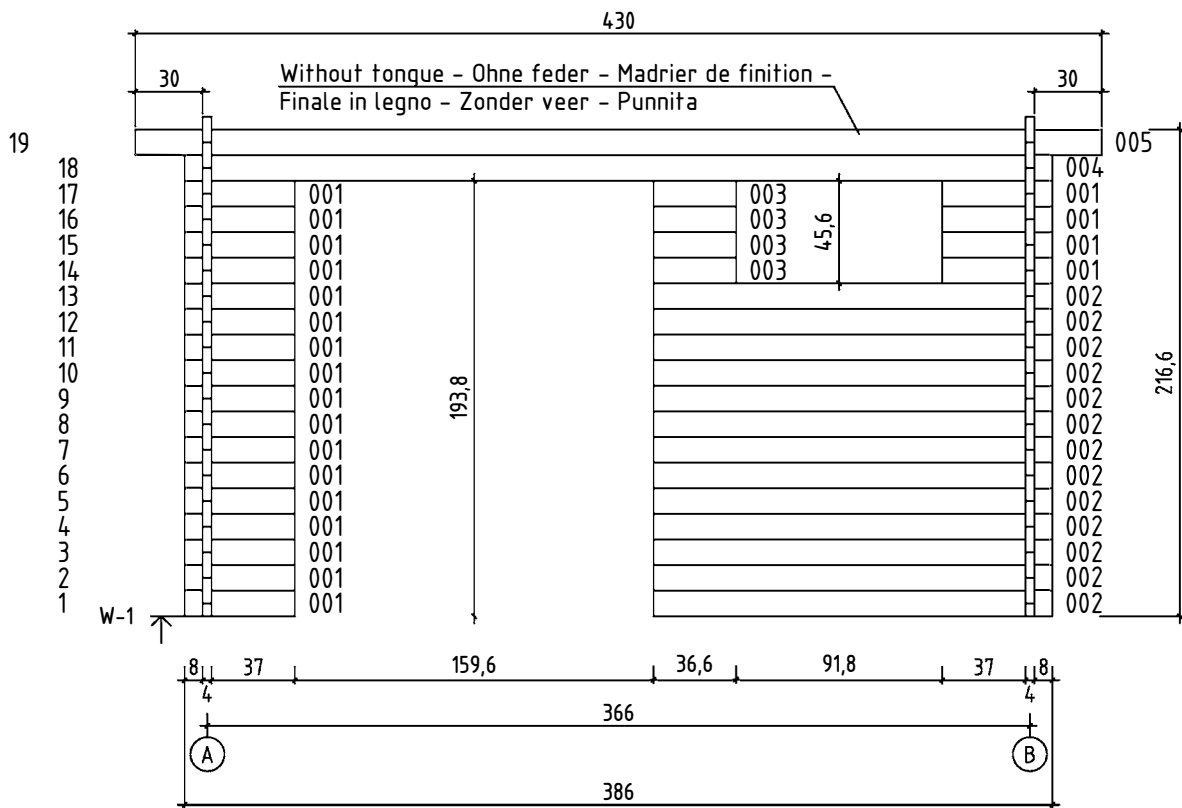

Wandplan A,B und C

540487

